

DENTAL CHAIR (FOLDING LEGREST TYPE)
INSTRUCTIONS FOR USE

Dear Customers

Dear Customers

Thank you for purchasing our product.

This booklet explains how to use DENTAL CHAIR (FOLDING LEGREST TYPE).

Before using DENTAL CHAIR (FOLDING LEGREST TYPE), carefully read the operating instructions and make sure to use the product correctly.

Using the product without reading these instructions may lead to an accident.

This document describes the full version of the system. It may therefore cover components that are not included in the system you purchased.

The specification is subject to change without notice.

| | |
|--------------------------|----------|
| 2020-04-01 (1st edition) | |
| REF | 1E07XUA0 |

Dear Customers

1 General Information

- 1-1 Intended Use of the Product
- 1-2 Compliance with Regulation and Directive
- 1-3 Declaration of Conformity
- 1-4 How to Dispose of the Device
- 1-5 Recommendation to user
- 1-6 Symbols
- 1-7 Technical Description

2 Safety Consideration

- 2-1 Risk Level Interpretation
- 2-2 Safety Precautions
 - 2-2-1 Points to remember when operating the product
- 2-3 EMC Information
- 2-4 Devices Connectable to the Product

3 Precautions for Use

- 3-1 Operating Precautions
- 3-2 Precautions for Using Synthetic Leathers

4 Specifications and Operation

- 4-1 EURUS SWIVEL CHAIR
 - 4-1-1 Specifications
 - 4-1-2 Dimensions
 - 4-1-3 Name of Each Part
 - 4-1-3-1 Chair
 - 4-1-3-2 Headrest
 - 4-1-4 Operation
 - 4-1-4-1 Preparation Before Use
 - 4-1-4-2 After use
 - 4-1-4-3 Raising/lowering the chair and raising/reclining the backrest (manual operation)
 - 4-1-4-4 Moving the chair to the preset position (automatic operation)
 - 4-1-4-5 Operating the headrest (manual type)
 - 4-1-4-6 Operating the headrest (electrohydraulic type)
 - 4-1-4-7 Relationship among the angles of the backrest, legrest and roll up legrest

4 Specifications and Operation

- 4-1-4-8 Operating the Legrest
- 4-1-4-9 Chair Rotation
- 4-1-4-10 Turning the armrest
- 4-1-4-11 Cancellation function
- 4-1-4-12 Chair lock function
- 4-1-4-13 Setting the treatment and entry/exit positions
- 4-1-4-14 Setting the mouth rinsing position
- 4-2 CLAIR CHAIR
 - 4-2-1 Specifications
 - 4-2-2 Dimensions
 - 4-2-3 Name of Each Part
 - 4-2-3-1 Chair
 - 4-2-3-2 Headrest
 - 4-2-4 Operation
 - 4-2-4-1 Preparation Before Use
 - 4-2-4-2 After use
 - 4-2-4-3 Raising/lowering the chair and raising/reclining the backrest (manual operation)
 - 4-2-4-4 Moving the chair to the preset position (automatic operation)
 - 4-2-4-5 Operating the headrest (manual type)
 - 4-2-4-6 Operating the headrest (Power Headrest Type)
 - 4-2-4-7 Relationship among the angles of the backrest, legrest and roll up legrest
 - 4-2-4-8 Turning the armrest
 - 4-2-4-9 Cancellation function
 - 4-2-4-10 Chair lock function
 - 4-2-4-11 Setting the treatment and entry/exit positions
 - 4-2-4-12 Setting the mouth rinsing position

5 Maintenance and Cleaning by Dental Staff

- 5-1 Methods for Care
- 5-2 Maintenance and Inspection
 - 5-2-1 Notes on daily maintenance and inspection (by the user)
 - 5-2-2 Notes for periodic inspection
- 5-3 Storage Instructions
- 5-4 Environmental Conditions for Transportation or Packaging

6 Maintenance by Service Engineers

- 6-1 After-sales Service
- 6-2 Service Life
- 6-3 Period of Parts Retention

7 Troubleshooting

- 7-1 Troubleshooting

8 Accessories and Consumables

- 8-1 Accessories
- 8-2 Consumables

1 General Information

1-1 Intended Use of the Product

This product is an active therapeutic device intended for the exclusive use for diagnoses, treatments and relative procedures of dentistry. The product must be operated or handled by the qualified dentists or by dental staffs under the supervision of the dentist. Such dentists or dental staffs should instruct and/or assist the patients to approach to and leave from the product. Patients should not be allowed to operate or handle the product unless he/she is so instructed.

1-2 Compliance with Regulation and Directive

This product complies with MDR (EU) 2017/745 and RoHS Directive 2011/65/EU.

1-3 Declaration of Conformity

We hereby declare that the product listed below complies with the essential requirements of the MDR (EU) 2017/745 and RoHS Directive 2011/65/EU based on category 8 of Annex I.

Product : DENTAL CHAIR (CLASS I)

Model : EURUS SWIVEL CHAIR
CLAIR CHAIR

" CLASS I " has been defined by the rule 13 of MDR Annex XIII. The product has been designed and manufactured in accordance with the European standards as the listed in the Declaration of Conformity.

1-4 How to Dispose of the Device





























When disposing of this product and parts replaced, carefully take infection control measures, pay attention to physical hazards such as from sharps, and handle them properly in accordance with the relevant laws and regulations (including local ordinances). In the EU area, EU Directive 2012/19/EU (Directive on Waste Electrical and Electronic Equipment [WEEE Directive]) applies to this product. Environment-conscious recycling/disposal is mandatory under this Directive.

1-5 Recommendation to user

A notice to the user and/or patient that any serious incident that has occurred in relation to the device should be reported to the manufacturer and the competent authority of the Member State in which the user and/or patient is established.

1 General Information

1-6 Symbols

| | | | |
|---|---|---|---|
|  | Switch (O N) |  | Switch (O F F) |
|  | Stick switch for automatic operation (EURUS SWIVEL CHAIR) |  | Stick switch for automatic operation (CLAIR CHAIR) |
|  | Stick switch for manual operation (EURUS SWIVEL CHAIR) |  | Stick switch for manual operation (CLAIR CHAIR) |
|  | Stick switch for headrest (EURUS SWIVEL CHAIR) |  | Stick switch for headrest (CLAIR CHAIR) |
|  | Alternating current |  | Protective earthing |
|  | Functional earthing |  | Name and address of the manufacturer |
|  | Date of manufacture |  | Compliance with MDR (EU) 2017/745, RoHS Directive 2011/65/EU |
|  | Separate collection of electrical and electronic equipment |  | European Authorized Representative |
|  | Serial Number |  | Catalog number |
|  | Caution |  | General warning sign |
|  | Flammable warning symbol |  | Type B Applied Parts contacting the patient's body surface only |
|  | Follow instructions for use |  | Generally prohibited activity |
|  | Disassembly, repair or modification prohibited |  | Instructions for mandatory actions in general |
|  | Indicates that the power plug must be removed from the socket |  | Medical Device |

1 General Information

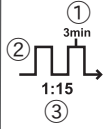
| | | | |
|--------------|------------------|---|---|
| MODEL | Product name | R.V. | Rated voltage |
| R.I. | Rated input |  | ① Maximum activation time ② Non-continuous operation ③ Duty cycle |
| JPN | Product of Japan | | |

1-7 Technical Description

The following are explained in the documents listed below:

| Item | Document |
|-----------------------------|---------------------------|
| How to install this product | Installation Instructions |
| Wiring/flow diagram | Installation Instructions |

2 Safety Consideration

2-1 Risk Level Interpretation

Precautions before use

Make sure to carefully read the Safety Precautions and Operating Precautions and use the product correctly.

These precautions are intended to ensure the safe use of the product and prevent harm or damage to users or other people.

According to the magnitude of harm and damage and the degree of urgency, an incident that may be caused by misuse of the product is classified into one of the following categories: CONTRAINDICATION, WARNING, and CAUTION.

All of these categories are important for safety. Always follow the instructions provided.

We assume no responsibility for any accident due to failure to follow the Safety Precautions or Operating Precautions even in the event of harm or damage to users or other persons.

In such case, users or other persons who use the product without observing the Safety Precautions and Operating Precautions are responsible for any harm or damage incurred.

The graphical symbols are explained in detail below.

Once you have fully understood this explanation, read the text.

2 Safety Consideration

Classification by degree of harm or damage and urgency

CONTRAINDICATION

Use of the product without regard to this indication will create a hazardous condition that may result in death or serious injury.



WARNING

Improper handling of the product without regard to this indication will create a hazardous condition that may result in death or serious injury.



CAUTION

Improper handling of the product without regard to this indication will create a potentially hazardous condition that may result in moderate or slight injury or property damage.

The following graphical symbols are used to explain your responsibilities for using the product safely:

Graphical symbols for prohibited activity



Generally prohibited activity



Disassembly, repair or modification prohibited

Graphical symbols for mandatory instructions



Instructions for mandatory actions in general



Indicates that the power plug must be removed from the socket.

2-2 Safety Precautions

CONTRAINDICATION

Installing or transferring the product



Precautions regarding installation

Do not install the product near electromagnetic sources such as communication facilities or elevators.

Malfunction of this product may occur in the presence of electromagnetic interference waves.

Use and maintenance of the product



Do not use the equipment in an explosive atmosphere (e.g., in the presence of inflammable gases).

Improper use in such an atmosphere may cause injury or fire.

Use with caution in the presence of electromagnetic waves.

Do not use equipment generating electromagnetic waves, such as mobile phones, around this product.

Malfunction of this product may occur.

Be sure to turn off the main switch of the product when HF surgical equipment is in use.

Be sure to turn off the main switch when HF surgical equipment is in use because the noise generated from HF surgical equipment may cause incorrect operation of this product.



Never disassemble, repair or modify the product.

Individuals other than your local authorized Belmont dealer should not disassemble or repair this product.

This could lead to an accident, failure, electric shock, or fire.

Never modify the product as it is extremely dangerous.

WARNING

Power Plug and Cord



Do not connect the earth (ground) to the following objects.

- Water pipes
(Complete grounding is not possible as hard plastic pipes are widely used.)
- Gas pipes (Can result in an explosion or fire)
- Lightning rods and telephone dedicated grounding wire (Dangerous during lightning)

Do not touch the power plug or socket with wet hands.

Failure to do so can result in electric shock.



Use a single socket (do not share a socket with other plugs).

Use an unshared socket with an attached ground terminal.

Using the same socket together with the power plug of other devices can result in abnormal heat generation and possible fire.

Firmly insert the power plug into the socket.

Be sure to fully insert the power plug into the socket until reaching the base of the plug.

Failure to fully insert the plug or similar fault can result in a short circuit or heat generation that causes a fire.

Wipe off the dirt on power plug and socket with a dry cloth to avoid any possible fire.

Hold by the power plug when unplugging.

Do not pull the cord to remove the power plug from the socket. Hold by the power plug at the end of the cord when removing. Removing the plug by pulling the power cord can damage the power cord, resulting in electric shock or fire.

Be careful when handling the power cord.

Damaging the cord can result in electric shock or fire.

- Do not damage the cord.
- Do not place objects on top of the cord.
- Do not alter the cord.
- Do not heat the cord.
- Do not excessively bend, twist, or pull the cord.

Be careful of power cord or plug breakage.

Do not use any power cord or plug that is damaged, or that fits loosely when inserted into a socket. Doing so can result in electric shock or fire.

WARNING

Power Plug and Cord



Securely connect to ground.

Failure to make a ground connection can result in electric shock if there is a malfunction or short circuit. Consult an electrician for grounding procedures.



Unplug the power plug when the chair is not in use.

Turn off the power switch and remove the power plug from the socket when the chair is not in use. Unexpected operation can result in an accident or fire from a short circuit due to insulation aging.

WARNING

Installing or transferring the product



Precautions for installation

Ask your local authorized Belmont dealer to install the product.

Make sure to place the product on a firm and flat floor. Placing the equipment on a non-flat floor may cause it to fall.

Be sure to ground the product securely. (Ask a professional to ground the product.)

Failure or electric leak may result in electric shock.

To avoid the risk of electric shock, this equipment must only be connected to a supply mains with protective earth.

This equipment must be connected to an appropriate power source.

Place no obstacles adjacent to the power socket for an easy access by the power plug.

Use and maintenance of the product



Keep moving parts of the product away from patients' and users' hands, fingers, and bodies.

Hands, fingers or bodies may become caught in the product, causing injury.

The patient must not lie on his/her stomach, kneel in the formal seiza position (with his/her buttocks on his/her heels), or sit on the product with a child in his/her arms.

The chair may move unexpectedly, causing injury.

The patient must not sit on the edge of the seat.

The chair may fall or move unexpectedly, causing injury or damage to peripheral devices.

The patient must not sit in an area other than the designated location.

Excessive load must not be applied to the product.

The patient must not sit on the headrest, armrest or backrest, or leg rest. This may cause injury due to falling, or damage to peripheral devices.

Do not wash the product with water.

This may cause failure or electric shock.

WARNING

Use and maintenance of the product

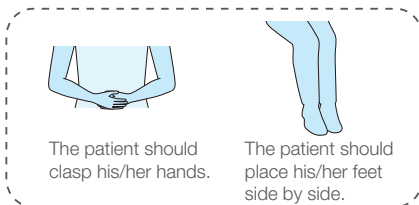

Perform cleaning before using the product for the first time. This product is not sterilized or disinfected when shipped.

Remove the patient's glasses and any accessories (such as a necklace or bracelets) before treatment.

Failure to follow this instruction may hamper treatment and lead to an accident.

Points to remember when a patient sits on the chair

As shown in the figure on the left, instruct the patient to sit on the chair and make sure his/her body fits into the chair.

Ensure that the patient maintains a good posture before moving the chair.

For a young child, the buttocks should be placed on the seat when raising the backrest.

Pay attention to patients and children.

Keep your eyes on the patient when this product is in use.

Patients (especially children) may touch the control switch or system inadvertently, leading to an accident due to incorrect operation of the product.

Keep children away from this product except when giving treatment.

Use and maintenance of the product



WARNING

Precautions for getting on and off this product

When the patient gets on or off this product, the chair should always be at the lowest position with the backrest at upright position and with the rotation being locked by the lock pedal.

Before moving a patient from a wheelchair to this product or vice versa, ensure that no obstacles are situated around the wheelchair or the caregiver.

Contact of the feet or the wheelchair castors with obstacles may cause injury or damage to peripheral devices.

When the patient is moved from a wheelchair to the product or vice versa, he/she must be carefully monitored to prevent falling.

If the patient has to get off the product at a position other than the designated position for getting on and off the product due to power failure or in the event of an emergency, he/she must be carefully monitored to prevent falling.

Precautions when raising/lowering the backrest

Before lowering the backrest, ensure that the patient's arm or hand is not sandwiched between the backrest and the seat.

Before raising the backrest, ensure that the patient's arm or hand is not sandwiched between the backrest and the armrest.

If the backrest is lowered during automatic operation, the legrest will be raised. Operate the backrest carefully to prevent the patient's toes from contacting the peripheral devices.

If the backrest is raised during automatic operation, the legrest will be lowered. Operate the backrest carefully after ensuring that the space beneath the legrest is clear of people and objects.

Precautions for operating the chair and automatic operation

Before and during the chair operation, pay close attention to the operation range (seat raising/lowering direction, backrest lowering/raising direction, and legrest traveling direction), and ensure that the chair does not contact any body parts, hands or feet, or objects. Body parts, hands or feet, or objects may become caught in the chair, causing injury or damage to peripheral devices.

Before operating the chair, ensure that the patient is sitting in the correct position, and keep your eyes on him/her when the chair is in use.

Precautions when using the headrest

When operating the headrest, check that the patient's head is in the correct position, and closely watch the patient during operation.

During the headrest operation, ensure that your hands, fingers, or hair do not become caught in the control lever and are not sandwiched between the headrest and the backrest.

Use and maintenance
of the product



WARNING

Precautions when using the legrest

Before raising/lowering the legrest, ensure that the chair does not contact any body parts, hands or feet, or objects.

Precautions during chair rotation

Make sure that no persons or objects are nearby before slowly rotating the chair.

Be careful of the following when rotating the chair in order to ensure safety.

- Lower the chair to the lowest position.
- Check that the patient is seated in the proper posture and position.
- Be sure that there are no other persons or things in the surrounding area, and ensure that the legrest and other parts do not contact the patient or any nearby equipment.

Be careful of the patient when the backrest is reclined and check that the safety of the patient is ensured before rotating the chair.

Be sure to always lock (secure) chair rotation after rotating the chair.

Always be sure that rotation is locked before operating the product. Accidental rotation of the product can result in injuries or damage to nearby equipment / instruments.

Pay close attention to a patient who has a cardiac pacemaker or defibrillator implanted.

If any abnormality occurs, immediately turn off the main switch and discontinue use of the product. the product may affect the function of the pacemaker or defibrillator, leading to an accident.

Prohibition of using this equipment adjacent to or stacked with other electronic equipment

Use of this equipment adjacent to or stacked with other equipment should be avoided because it could result in improper operation. If such use is necessary, this equipment and the other equipment should be observed to verify that they are operating normally.

Prohibition of placing portable RF communications equipment adjacent to this product

Portable RF communications equipment (including peripherals such as antenna cables and external antennas) should be used no closer than 30 cm(12 inches) to any part of EURUS SWIVEL CHAIR/ CLAIR CHAIR, including cables specified by the manufacturer. Otherwise, degradation of the performance of this equipment could result.

Use and maintenance of the product



WARNING

Immediately wipe off any water spillage or leakage on the floor.

Decreased strength of the floor may cause the product to fall, leading to injury or damage to peripheral devices.

Clean the product thoroughly.

Poor cleaning may cause bacteria to grow, posing a health risk.

Be sure to conduct maintenance.

Use of the product without maintenance may cause injury or damage to peripheral devices.

Prohibition of maintenance

During operation, repair and maintenance are prohibited.

Discontinue use of the product if it is broken.

In the case of a broken product, immediately discontinue use and turn off the main switch. Then, ask your local authorized Belmont dealer to repair the product.

Be sure to turn off the breaker for devices when the product is not used for a long period of time.

Make sure to turn off the breaker for devices in a clinic when the product is not used for a long time for reasons such as closing time and non-consultation day.

If the breaker is not turned off, a fire may be caused by a leakage of electricity due to insulation deterioration.



Turn off the power switch and unplug the power plug before cleaning.

Failure to follow this instruction may cause electric shock or ignition. The product may also move unexpectedly, causing injury.

Action taken for power failure

To prevent unexpected operation of the product after recovery from power failure, turn off the main switch.

Use and maintenance
of the product



CAUTION

Do not allow a person who exceeds the weight limit to sit on the chair.

Falling or operational failure may occur.
[Reference] Weight limit

Do not hit or rub the product.

This may cause damage to the cover or operational failure.

Ensure that each part operates normally, with no abnormalities detected, before operation.

Always inspect the product for abnormal findings such as loose components, backlash, tilting, vibration, sound, abnormal temperature, or bad odors.

If you feel something is wrong, immediately discontinue use of the product and turn off the main switch. Then, contact your local authorized Belmont dealer.

Read the Instructions for use.

Before use, make sure to carefully read the instructions for use and use the device correctly.

Be sure to operate switches manually.

Make sure to operate the switches manually, except for the foot controller operated by the foot and stick switches. Failure to operate the switches by hand may cause damage or malfunction.

Carefully operate the switches to prevent a mistake.

The operator should pay close attention to people around the product and say something before operation to prevent any errors.

Precautions for armrest rotation

Ensure that no obstacles are placed around the armrest and fingers do not become caught in the armrest.

Do not operate the chair when the armrest is rotated. Before operating the chair, return the armrest to its original position.

Be careful that the power cord is not caught up by your feet or legs.

Failure to do so can result in injury.

Use and maintenance of the product



CAUTION

Immediately wipe off any drug solutions or water adhered to the product.

Adherence of drug solutions or water to the product may cause operational failure or electrical leak. If drug solutions or water are adhered, immediately turn off the main switch and wipe them off with a dry, soft cloth.

Be careful not to get water or any chemical on the headrest support frame. Wipe off all water and chemicals immediately if any gets on these parts. Failure to do so can prevent the headrest from being securely fixed because of corrosion or degradation of friction force due to rust.

Turn off the main switch at the end of day or during a recess. Malfunction due to contact with the product will cause damage or injury.

Precautions for cleaning

Be careful when cleaning the chair that your hands, fingers or other body parts are not injured.

2-2-1 Points to remember when operating the product

Meaning of a symbol

 Point to remember
(locations requiring attention including moving parts, rotating parts, and detachable parts)

 Point to remember where an emergency stop mechanism is available

Meanings of each point to remember



1 Pay attention to prevent body parts or objects from becoming caught in the headrest moving part.
Ensure that your fingers and hair do not become caught in the headrest moving part.

2 Pay attention to prevent body parts or objects from becoming caught in the backrest moving parts.
Do not sandwich your hands or feet between the backrest and the seat.

3 Pay attention to prevent body parts or objects from becoming caught in the armrest (when rotating).
Do not operate the chair when the armrest is 180 degrees rotated.

4 Pay attention to prevent body parts or objects from becoming caught in the bottom of the seat.
Do not place your hands or feet in the bottom of the seat.

5 Pay attention to prevent body parts or objects from becoming caught in the bottom of the legrest.
Ensure that feet are not placed beneath the legrest.

2-3 EMC Information

This product complies with EMC Standard EN60601-1-2:2015.

1. Precautions regarding EMC and compliance with accompanying documents

Medical electrical equipment requires special precautions regarding EMC and needs to be installed and put into service according to the EMC information provided in this booklet.

2. Effects of RF communication devices

Portable and mobile RF communication devices can affect medical electrical equipment.

3. Installation exclusion environment

Hospitals except for near active HF SURGICAL EQUIPMENT and the RF shielded room of an ME SYSTEM for magnetic resonance imaging, where the intensity of EM DISTURBANCES is high.

4. Electromagnetic emission declaration

| Guidance and manufacturer's declaration—electromagnetic emissions | | |
|---|------------|---|
| This product is intended for use in the electromagnetic environment specified below. The customer or user of this product should ensure that it is used in such an environment. | | |
| Emissions test | Compliance | Electromagnetic environment—guidance |
| RF emissions CISPR 11 | Group 1 | This product only uses RF energy for its internal functions. Therefore, its RF emissions are very low and are not likely to cause any interference with nearby electronic equipment. |
| RF emissions CISPR 11 | Class B | This product is suitable for use in all establishments, including domestic establishments and those directly connected to the public low-voltage power supply network that supplies buildings used for domestic purposes. |
| Harmonic emissions IEC 61000-3-2 | Class A | |
| Voltage fluctuations/ Flicker emissions IEC 61000-3-3 | Complies | |



Use of this equipment adjacent to or stacked with other equipment should be avoided because it could result in improper operation. If such use is necessary, this equipment and the other equipment should be observed to verify that they are operating normally.

5. Electromagnetic immunity declaration 1

| Guidance and manufacturer's declaration—electromagnetic immunity | | | |
|---|--|--|--|
| This product is intended for use in the electromagnetic environment specified below. The customer or user of this product should ensure that it is used in such an environment. | | | |
| Immunity test | IEC 60601 test level | Compliance level | Electromagnetic environment—guidance |
| Electrostatic discharge (ESD) IEC 61000-4-2 | ±8 kV contact ±15 kV air | ±8 kV contact ±15 kV air | Flooring should be wood, concrete, or ceramic tiles. If the floor is covered with synthetic material, the relative humidity should be at least 30%. |
| Electrical fast transient/burst IEC 61000-4-4 | ±2 kV for power supply lines ±1 kV for input/output lines | ±2 kV for power supply lines ±1 kV for input/output lines | The mains power quality should be that of a typical commercial or hospital environment. |
| Surge IEC 61000-4-5 | ±1kV differential mode ±2kV common mode | ±1kV differential mode ±2kV common mode | The mains power quality should be that of a typical commercial or hospital environment. |
| Voltage dips, short interruptions and voltage variations on power supply input lines IEC 61000-4-11 | 0% UT ; 0.5 cycles 0°, 45°, 90°, 135°, 180°, 225°, 270° and 315° 0% UT ; 1 cycle and 70% UT ; 25/30 cycles at 0°, single phase 0% UT ; 250/300 cycles | 0% UT ; 0.5 cycles 0°, 45°, 90°, 135°, 180°, 225°, 270° and 315° 0% UT ; 1 cycle and 70% UT ; 25/30 cycles at 0°, single phase 0% UT ; 250/300 cycles | The mains power quality should be that of a typical commercial or hospital environment. If the user of this product requires continued operation during mains power interruptions, it is recommended that this product be powered from an uninterruptible power supply or a battery. |
| Power frequency (50/60 Hz) magnetic field IEC 61000-4-8 | 30A/m | 30A/m | Power frequency magnetic fields should be at levels characteristic of a typical location in a typical commercial or hospital environment. |
| Note Ur is the AC mains voltage prior to the application of the test level. | | | |

6. Electromagnetic immunity declaration 2

| Guidance and manufacturer's declaration—electromagnetic immunity | | | |
|---|--|--|--|
| This product is intended for use in the electromagnetic environment specified below. The customer or user of this product should ensure that it is used in such an environment. | | | |
| Immunity test | IEC 60601 test level | Compliance level | Electromagnetic environment—guidance |
| Conducted RF IEC 61000-4-6 | 3V 0.15MHz~ 80MHz | 3V 0.15MHz~ 80MHz | Warning: Portable RF communications equipment (including peripherals such as antenna cables and external antennas) should be used no closer than 30 cm(12 inches) to any part of EURUS SWIVEL CHAIR/CLAIR CHAIR, including cables specified by the manufacturer. Otherwise, degradation of the performance of this equipment could result. |
| | 6V 0.15MHz~ 80MHz in ISM and amateur radio bands | 6V 0.15MHz~ 80MHz in ISM and amateur radio bands | |
| Radiated RF IEC 61000-4-3 | 3V/m 80MHz~ 2.7GHz 80% AM (1 kHz) | 3V/m 80MHz~ 2.7GHz 80% AM (1 kHz) | |
| Near electromagnetic field caused by RF wireless communication devices IEC61000-4-3 | See the table on the next page | See the table on the next page | |

7. Essential performance

Unless operated by the chair control switch, the chair will not make any movements except for sounding a buzzer and switching the indicator on/off.

Loss or decline of essential performance may cause the chair to move unexpectedly, causing harm to the patient, operator or people or objects around the patient or operator.



Portable RF communications equipment (including peripherals such as antenna cables and external antennas) should be used no closer than 30 cm(12 inches) to any part of EURUS SWIVEL CHAIR/CLAIR CHAIR, including cables specified by the manufacturer.

Otherwise, degradation of the performance of this equipment could result.

2 Safety Consideration

Near electromagnetic field caused by RF wireless communication devices

| Test frequency (MHz) | Modulation | IEC 60601 test level | IEC 60601 compliance level |
|--|---|----------------------|----------------------------|
| 385 | Pulse modulation ^{a)} 18Hz | 27V/m | 27V/m |
| 450 | Frequency modulation ±5kHz shift 1kHz sine wave | 28V/m | 28V/m |
| 710 745 780 | Pulse modulation ^{a)} 217Hz | 9V/m | 9V/m |
| 810 870 930 | Pulse modulation ^{a)} 18Hz | 28V/m | 28V/m |
| 1720 1845 1970 | Pulse modulation ^{a)} 217Hz | 28V/m | 28V/m |
| 2450 | Pulse modulation ^{a)} 217Hz | 28V/m | 28V/m |
| 5240 5500 5785 | Pulse modulation ^{a)} 217Hz | 9V/m | 9V/m |
| Note a) The carrier is modulated by a square wave with a 50% duty cycle. | | | |

2 Safety Consideration

2-4 Devices Connectable to the Product

Use this product in combination with the unit marked with a circle.

| | Devices connectable |
|--------------------|---------------------|
| TYPE | CLESTA II / CELEB |
| EURUS SWIVEL CHAIR | |
| CLAIR CHAIR | ○ |

3 Precautions for Use

3-1 Operating Precautions

Immediately wipe off any drug solutions adhered to the product.

Otherwise, they may cause deterioration or discoloration.

Do not apply heat to this product.

This may cause deterioration or discoloration.

Discoloration of resin

Resin materials are used in external components of the product. Carefully selected materials are used; however, discoloration may occur for reasons such as natural deterioration or the adherence of drug solutions.

To ensure use of the product for as long as possible, immediately wipe off any drug solutions adhered and avoid sunlight.

Precautions for cleaning the resin cover

for cleaning, do not use cleaning agents containing solvent or abrasives, thinners or oil-based alcohol (butanol and isopropyl alcohol), which may cause cracks.

Do not place objects other than a human being on the seat.

This may cause deformation, tears, or corrosion of the leather.

Use this product only for dental treatment.

This product is patient chair used for dental treatment.

Only a dentist and dental staff are allowed to use this product.

Chair's weight limit

The chair may rise slowly if a person weighs around the maximum lifting capability.

[Reference] Weight limit

Cleaning before and after using

Be sure to clean the product before and after use.

Turn off the power before cleaning.

3-2 Precautions for Using Synthetic Leathers

Adherence of clothing dye

To clean and disinfect the synthetic leathers, wipe the surface with a soft cloth or paper towel moistened with FD360 manufactured by Dürr, and then wipe it with a dry cloth.

Dye may migrate from clothes or belts to the synthetic leathers of the product. If dye is adhered, wipe gently with a soft cloth impregnated with a neutral detergent diluted to about one-tenth with water as soon as possible to prevent penetration. Next, wipe with water and then thoroughly with a dry cloth.

Pay attention to prevent deterioration and dye migration due to contact.

Contact with other resin materials, coated products, solvents, and adhesive tapes may cause changes in the surface gloss, cracks, deformation or abrasion.

Dye may migrate from newspapers or printed matters to this product.

Dye may migrate from printed clothes such as T-shirts or denim clothes to the leathers of this product.

Adherence of benzene, nail polish remover, alcohol, or oil may cause discoloration, surface dissolution, changes in gloss, hardening, softening or abrasion.

Use of a bleaching agent or a sheet cleaned by bleach may cause changes in gloss or discoloration.

Placing the product near a heat source such as a heater may cause deformation or discoloration.

Shield the product from direct sunlight by using a curtain. Direct sunlight may cause surface change, shrinkage, discoloration or fading.

Placing a heavy object on the product for a long time may leave a mark or wrinkle on the synthetic that cannot be removed.

4 Specifications and Operation

4-1 EURUS SWIVEL CHAIR

4-1-1 Specifications

| | |
|---|---|
| Model No. | AC-ERS-FD* |
| | (* represents single or multiple strings or numbers.) |
| Classification for protection against electric shock | Class I equipment |
| Classification according to the degree of protection against electric shock ... | B-type isolated applied parts (leather-covered parts) |
| Rated Power Supply | AC230V 50/60Hz 2.0A |
| Fuse | P.C.B. for Chair control 1.25A/250V (Breaking Capacity : 1500A/250VAC) Operating speed:Fast-blow Size:5.2x20mm |
| Operation mode | Non-Continuous Operation (Motor) Duration of Maximum Operating Time:3min Duty 1:15 |
| Weight | 167kg |
| Chair Initial Height/Stroke | 480/245mm |
| Chair raising and lowering mechanism | Electrohydraulic |
| Weight limit | 165kg |
| Headrest | Manual |
| Backrest | Electrohydraulic |
| Seat | With Backrest Synchronized Tilting Mechanism |
| Legrest | Electrohydraulic |
| Roll up Legrest | Electrohydraulic |
| Armrest | With rotation function on both sides |
| Upholstered parts | Synthetic Leather |
| Control switch | Stick Switch |
| Usage environment | Temperature 0 ~ 40°C Humidity 10 ~ 95% Atmospheric pressure 700 ~ 1060 hPa |

4-1-2 Dimensions

Unit: mm (Dimensional tolerance:±10%)
*1 (): Flat seat

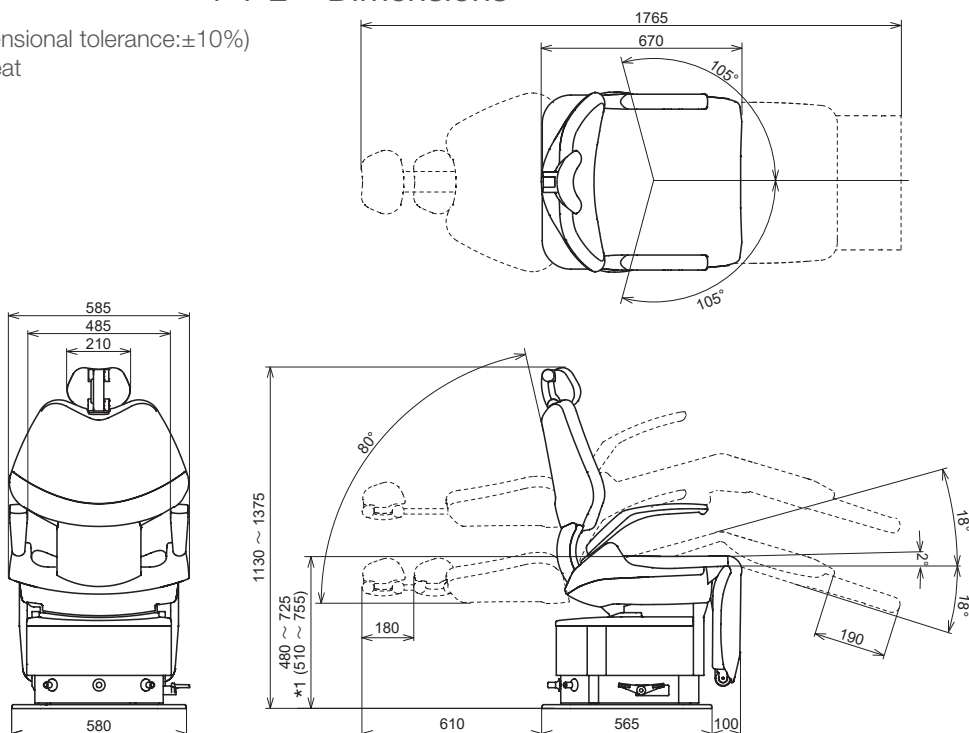

Refer to the rating plate for the capacity of power supply.

4 Specifications and Operation

| | |
|---|---|
| Model No. | AC-ERS-FP * |
| | (* represents single or multiple strings or numbers.) |
| Classification for protection against electric shock | Class I equipment |
| Classification according to the degree of protection against electric shock ... | B-type isolated applied parts (leather-covered parts) |
| Rated Power Supply | AC230V 50/60Hz 2.0A |
| Fuse | P.C.B. for Chair control 1.25A/250V (Breaking Capacity : 1500A/250VAC) Operating speed:Fast-blow Size:5.2x20mm |
| Operation mode | Non-Continuous Operation (Motor) Duration of Maximum Operating Time:3min Duty 1:15 |
| Weight | 170kg |
| Chair Initial Height/Stroke | 480/245mm |
| Chair raising and lowering mechanism | Electrohydraulic |
| Weight limit | 165kg |
| Headrest | Electrohydraulic |
| Backrest | Electrohydraulic |
| Seat | With Backrest Synchronized Tilting Mechanism |
| Legrest | Electrohydraulic |
| Roll up Legrest | Electrohydraulic |
| Armrest | With rotation function on both sides |
| Upholstered parts | Synthetic Leather |
| Control switch | Stick Switch |
| Usage environment | Temperature 0 ~ 40°C Humidity 10 ~ 95% Atmospheric pressure 700 ~ 1060 hPa |

Unit: mm (Dimensional tolerance:±10%)
*1 () : Flat seat

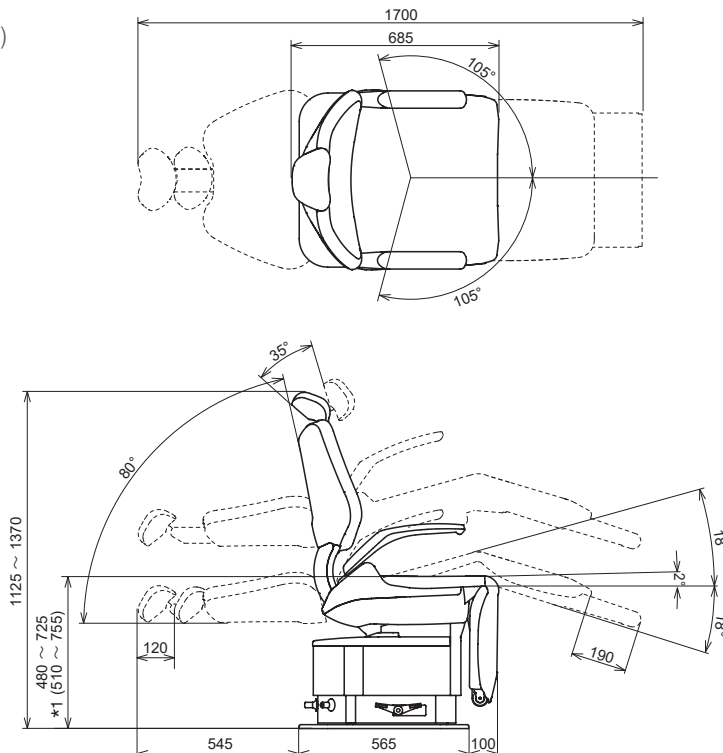
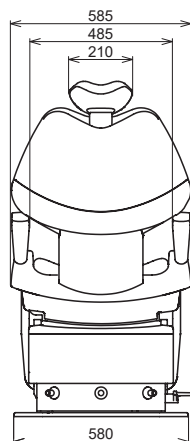

Refer to the rating plate for the capacity of power supply.

4 Specifications and Operation

4-1-3 Name of Each Part

4-1-3-1 Chair

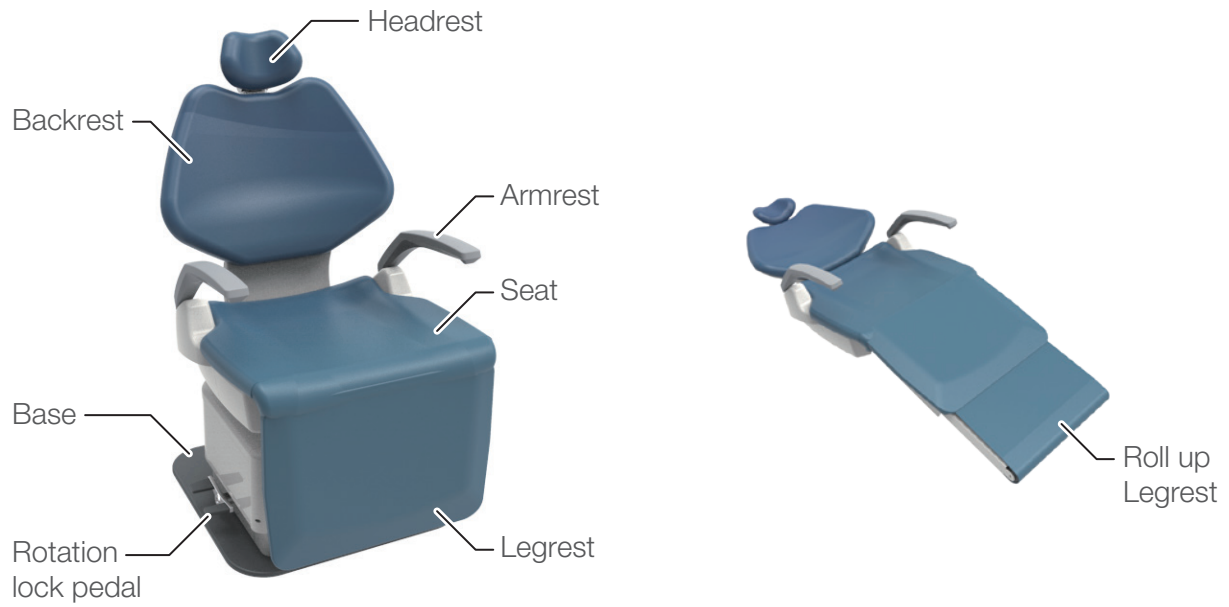

4-1-3-2 Headrest

Manual Headrest Type

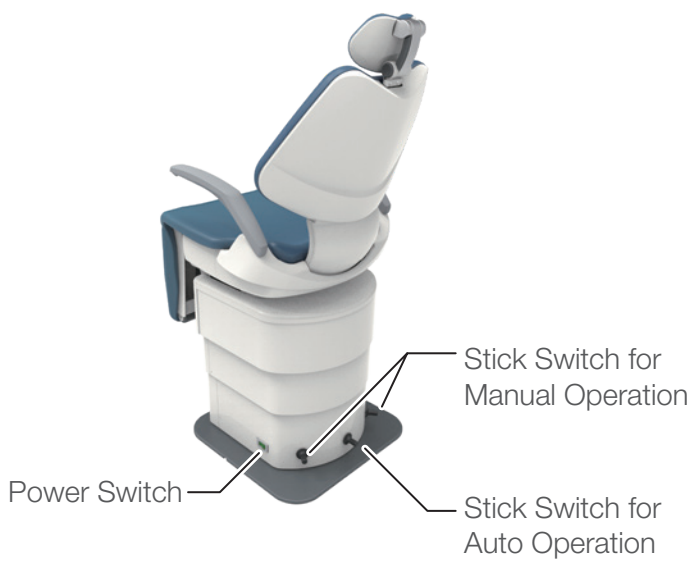

Power Headrest Type

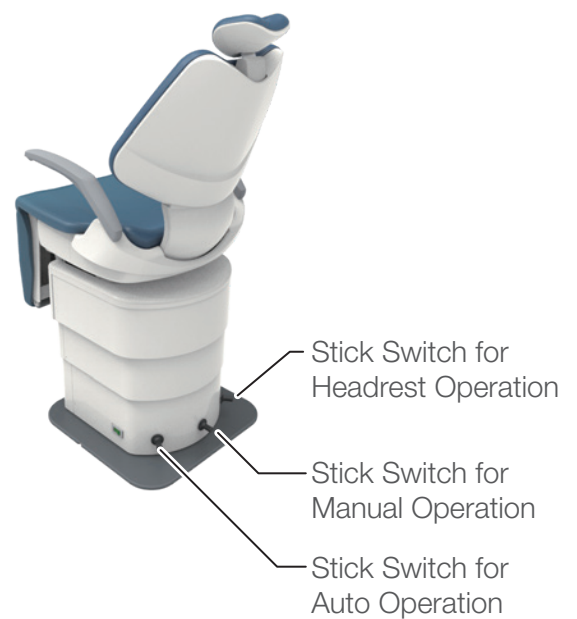

4-1-4 Operation

4-1-4-1 Preparation Before Use

Inserting the power plug into the socket

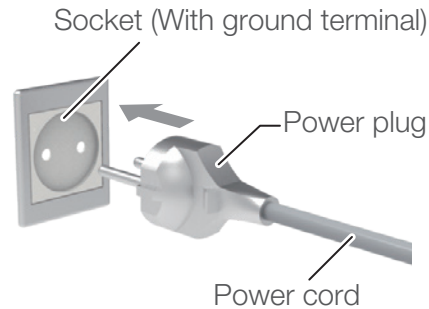

WARNING

Use an unshared socket with an attached ground terminal.

Be sure to fully insert the power plug into the socket until reaching the base of the plug.

Wipe off the dirt on power plug and socket with a dry cloth to avoid any possible fire.

Do not pull the cord to remove the power plug from the socket. Hold by the power plug at the end of the cord when removing.

Be careful when handling the power cord.

- Do not damage the cord.
- Do not place objects on top of the cord.
- Do not alter the cord.
- Do not heat the cord.
- Do not excessively bend, twist, or pull the cord.

Be careful of power cord or plug breakage.

Do not use any power cord or plug that is damaged, or that fits loosely when inserted into a socket.

Do not touch a power plug or socket with a wet hand.

Do not connect the earth (ground) to the following objects.

Water or gas pipes, lightning rods and telephone dedicated grounding wire

Consult an electrician for grounding procedures to ensure secure ground connections.

Turn off the power switch and remove the power plug from the socket when the chair is not in use.

Turning on the power



CAUTION

Operate the main switch for chair by hand.

4-1-4-2 After use

Turn off the power for chair

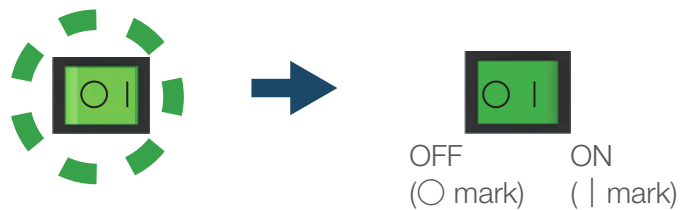

CAUTION

Operate the main switch for chair by hand.

4 Specifications and Operation

4-1-4-3 Raising/lowering the chair and raising/reclining the backrest (manual operation)

Manual Headrest Type



Stick Switch for Manual Operation

Power Headrest Type



Stick Switch for Manual Operation

| Stick switch | | Operation |
|-------------------|------------------|-----------|
| Pushing direction | Label indication | |
| | | |
| | | |
| | | |
| | | |

*The chair is operated while the stick switch is pushed down or the switch is pressed.

WARNING

Before raising/lowering the chair, ensure that the chair does not contact any body parts, hands, feet, or objects.

Before reclining the backrest, confirm that the patient's arm or hand is not placed between the backrest and the seat.

Before raising the backrest, confirm that the patient's arm or hand is not placed between the backrest and the armrest.

[Reference] Precautions when a patient is seated

4 Specifications and Operation

4-1-4-4 Moving the chair to the preset position (automatic operation)

Manual Headrest Type



Stick Switch for Auto Operation

Power Headrest Type



Stick Switch for Auto Operation

| Stick switch | | Operation |
|-------------------|------------------|---|
| Pushing direction | Label indication | |
| | | <p>"Treatment position 1".</p> |
| | | <p>"Treatment position 2".</p> |
| | | <p>"Entry/exit position".</p> |
| | | <p>"Return headrest".(Power headrest)</p> |
| | | <p>"mouth rinsing position".</p> |
| | | <p>"Previous position".</p> |

Do not depress the auto operation stick switch for over 5 seconds, because the memorized position in auto mode may be changed.
 [Reference] Changing Treatment Position, Mouth rinsing Position and Entry/Exit Position

WARNING

Before moving the chair, confirm that no human body part, limb, or object is obstructing the chair.

4-1-4-5 Operating the headrest (manual type)

Adjustment of the headrest

The headrest is capable of flexibly adjusting the inclination of the patient's head for treatment in the upper/lower jaw. It is also possible to manually extend/fold the headrest in accordance with the patient's height.

Angle adjustment of the headrest

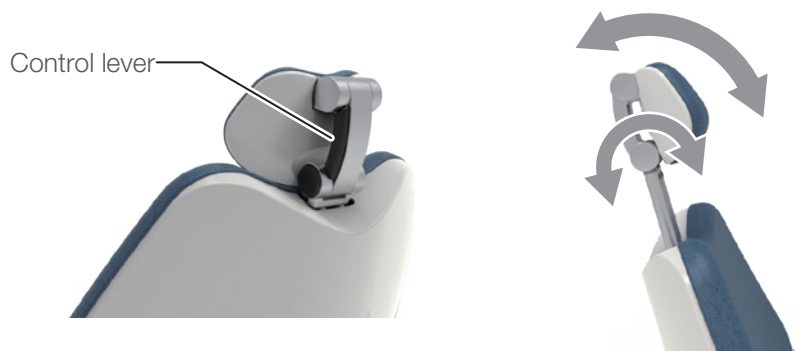

Up/down adjustment of the headrest



Do not apply excessive load or impact to the headrest while it is extended. Do not hit the headrest from above. Otherwise, failure may result.

WARNING

If the chair is to be moved with the backrest reclined while the headrest is extended, confirm that there is no object obstructing or coming into contact with the chair. This may cause damage or injury.

When operating the headrest, be careful not to get the operator's hand or finger caught around the control lever or between the headrest and the backrest.

When adjusting the angle or up/down, be sure to apply the operator's hand to the headrest and support the patient's head. Otherwise, an accident or injury may result.

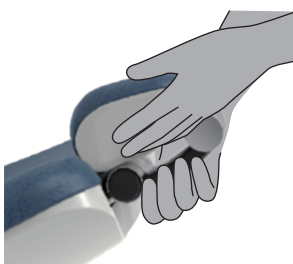

4 Specifications and Operation

4-1-4-6 Operating the headrest (electrohydraulic type)



| Stick switch | | Operation |
|-------------------|------------------|-------------|
| Pushing direction | Label indication | |
| | | Extend |
| | | Lower |
| | | Raise |
| | | Recline |

*The chair is operated while the stick switch is pushed down.

Do not apply an excessive load or impact on the headrest. Otherwise, failure may result.

WARNING

When operating the headrest, check that the patient's head is in the correct position, and closely watch the patient during operation.

Be careful when operating the headrest that fingers and other body parts are not pinched in between the headrest and backrest.

4 Specifications and Operation

4-1-4-7 Relationship among the angles of the backrest, legrest and roll up legrest

Manual Headrest Type

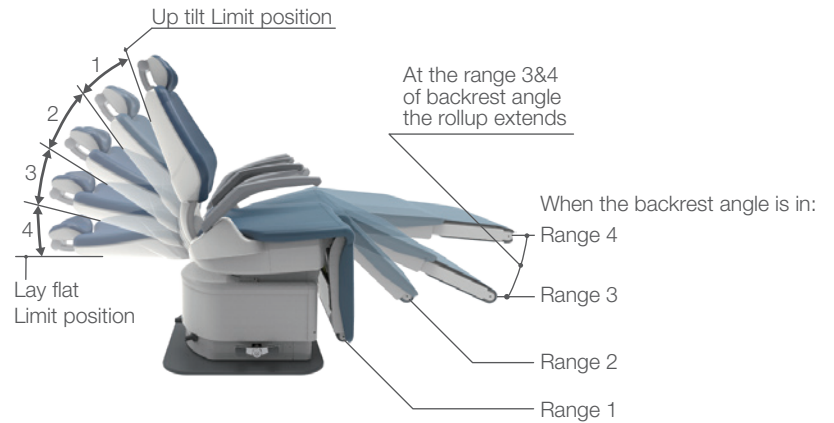

Power Headrest Type

Headrest up/down position

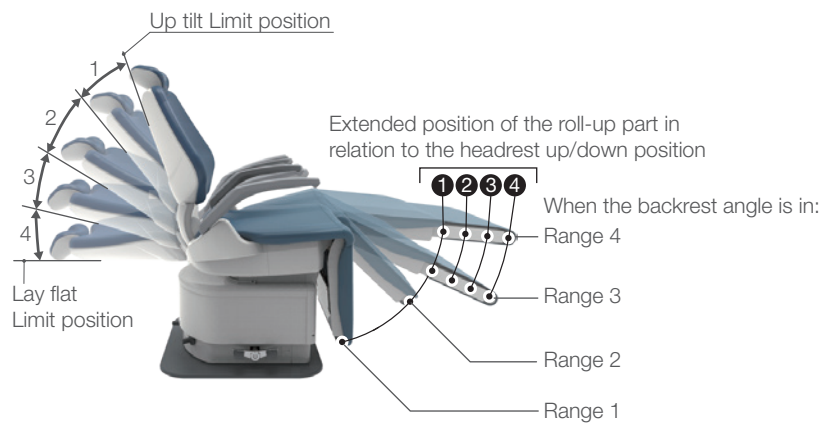
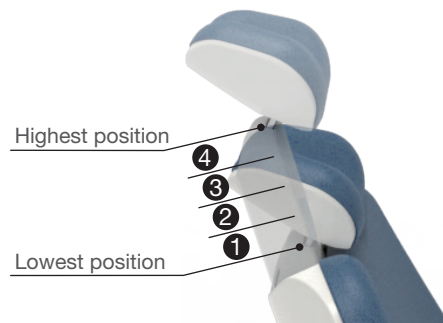

4 Specifications and Operation

4-1-4-8 Operating the Legrest

"Legrest operation mode" controls the legrest operation.

Manual Headrest Type Power Headrest Type



Stick Switch for Auto Operation

1 legrest operation mode activation



Beeps from 5 seconds



Another beeps from 8 seconds

Keep pushing

Do not leave the stick switch for auto operation while the beeps are sounding. When leaving the stick switch, the position at the moment is memorized as the mouth rinsing position.
[Reference] Changing Treatment Position, Mouth rinsing Position and Entry/Exit Position

2 Operate the legrest by the stick switch for manual operation.

Manual Headrest Type Power Headrest Type



Stick Switch for Manual Operation

| Stick switch | | Operation |
|-------------------|------------------|-----------------------|
| Pushing direction | Label indication | |
| | | Raise the legrest |
| | | Raise the legrest |

*The legrest can be moved while the switch is pressed down.

Manual Headrest Type

The extension range of the roll-up legrest is determined automatically by the angle of legrest.

Power Headrest Type

The extension range of the roll-up legrest is determined by the angle of legrest and the height of headrest.

3 To cancel the legrest operation mode, turn the stick switch for backrest operation to any directions for one second or more.

WARNING

Before raising/lowering the legrest, confirm that no human body part, limb, or object is obstructing the chair.

4 Specifications and Operation

4-1-4-9 Chair Rotation

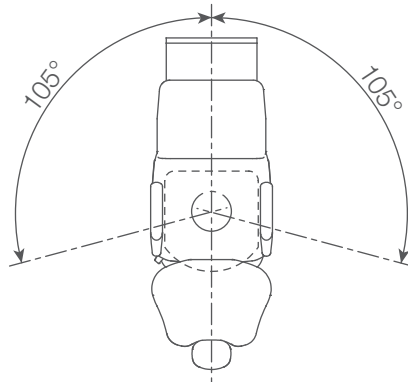
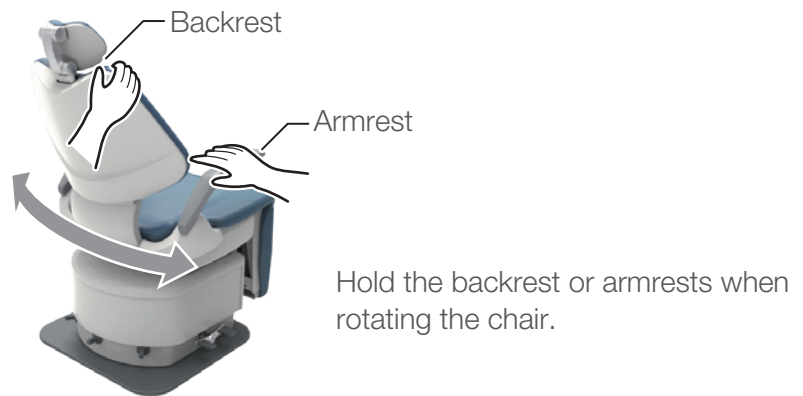
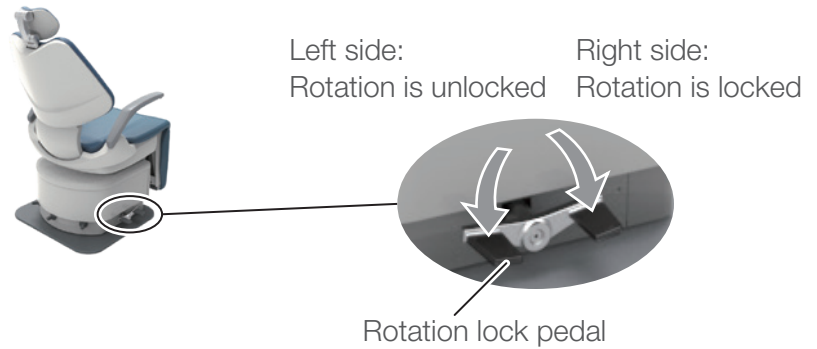

WARNING

When the patient sits on or gets out of the seat, be sure to put the product in the entry/exit position (seat is lowered to the bottom, the backrest is raised, and the rotating mechanism is locked).

Be careful of the following when rotating the chair in order to ensure safety.

- Lower the chair to the lowest position.
- Check that the patient is seated in the proper posture and position.
- Be sure that there are no other persons or things in the surrounding area, and ensure that the legrest and other parts do not contact the patient or any nearby equipment.

Be sure to always lock (secure) chair rotation after rotating the chair.

4-1-4-10 Turning the armrest

If the armrest hinders entry/exit or diagnosis, it may be turned backward.

Both the left and right armrests can be turned.



CAUTION

When turning the armrest, confirm that there is no obstruction.

Operator must be careful not to get their hand or finger caught.
Do not move the chair while the armrest has been turned backward.
Return the armrest to the normal position before moving the chair.

4 Specifications and Operation

4-1-4-11 Cancellation function





Stick Switch

To stop the chair movement started by a switch for automatic operation (preset switch, automatic return switch, last position switch, or stick switch for automatic operation), perform one of the following operations.

Operate one of the stick switches (indicated with ○).

4-1-4-12 Chair lock function

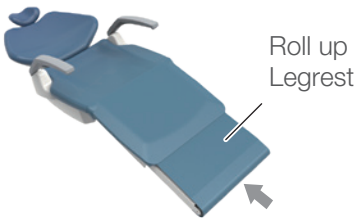
When the lock function is activated, the chair movement is stopped. The functions that become locked and the unlocking steps are as follows.

| Condition | How to unlock |
|---|---|
| <p>If a certain amount of force is applied in the direction of the arrow to the roll up legrest during operation, the pinching prevention function will operate, and the seat will rise for approx. 1 second and then stop.</p> | <p>Remove the cause of the stoppage, confirm the safety, then restart operation.</p> |
| <p>*While the legrest is rising by auto operation, the pinching prevention function will operate within the range of the legrest vertical to approx. 55°. Beyond this range, the pinching prevention function will not operate.</p> | <p style="text-align: center;">Locked functions</p> |
| <p>Legrest is rising by auto operation</p>  <p>Lowering by manual / auto operation</p>  | <p>Automatic operation of the chair Manual operation (lowering, reclining the backrest)</p> |

4 Specifications and Operation

4-1-4-13 Setting the treatment and entry/exit positions

Manual Headrest Type

Power Headrest Type

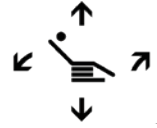

Set the treatment position by chair manual switch



Manual Headrest Type

Power Headrest Type

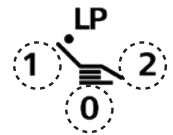

Keep pressing 5seconds.
1,2: Chair preset position
0:Auto return position

4-1-4-14 Setting the mouth rinsing position

Manual Headrest Type

Power Headrest Type



Set the treatment position by chair manual switch



Manual Headrest Type

Power Headrest Type

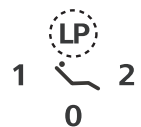

Keep pressing 5seconds.
LP: Last position

4 Specifications and Operation

4-2 CLAIR CHAIR

4-2-1 Specifications

| | |
|---|--|
| Model No. | AC-CLR-230* |
| | (* represents single or multiple strings or numbers.) |
| Classification according to the degree of protection against electric shock | Type B applied part : Seat for chair |
| Rated Power Supply | AC230V 50/60Hz 2.0A |
| Fuse | P.C.B. for Chair control 5A/250V (Current Rating : 50A at 250VAC) Operating speed:Fast-blow Size:5.2x20mm |
| Operation mode | Non-Continuous Operation Duration of Maximum Operating Time:3min Duty 1:5 |
| Weight | 150kg |
| Chair Initial height/stroke | 450mm (500mm CE Spec.)/265mm |
| Weight limit | 135kg |
| Backrest Movement | 0° ~ 80° above Horizontal |
| Tilting Mechanism | Backrest Synchronized Tilting (2° ~ 16° above Horizontal) |
| Auto Movements | 2-Preset, 1-Last Position Memory and 1-Auto Return |
| Control Voltage | DC12V |
| Usage environment | Temperature 0 ~ 40°C Humidity 10 ~ 95% Atmospheric pressure 700 ~ 1060 hPa |

4-2-2 Dimensions

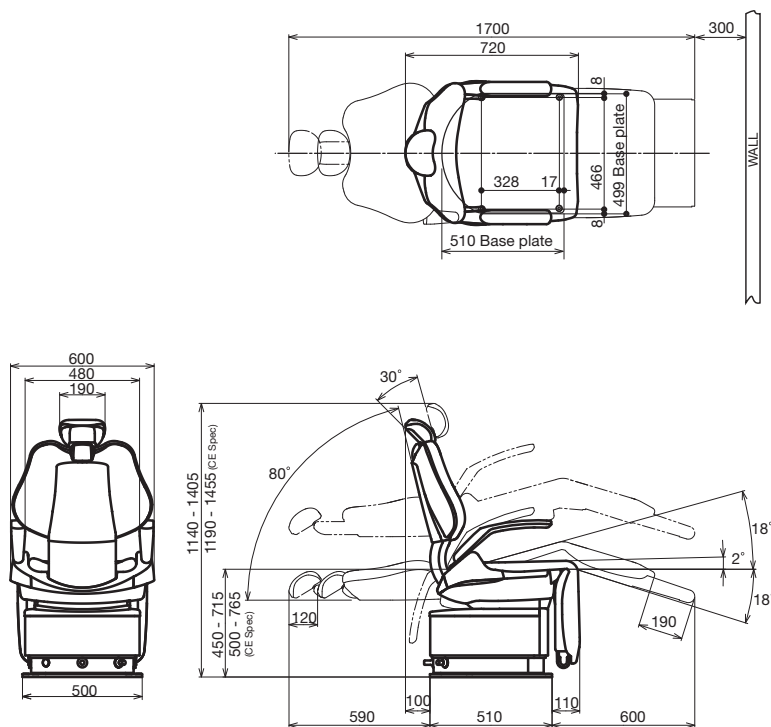

Unit: mm

Refer to the rating plate for the capacity of power supply.

4 Specifications and Operation

4-2-3 Name of Each Part

4-2-3-1 Chair

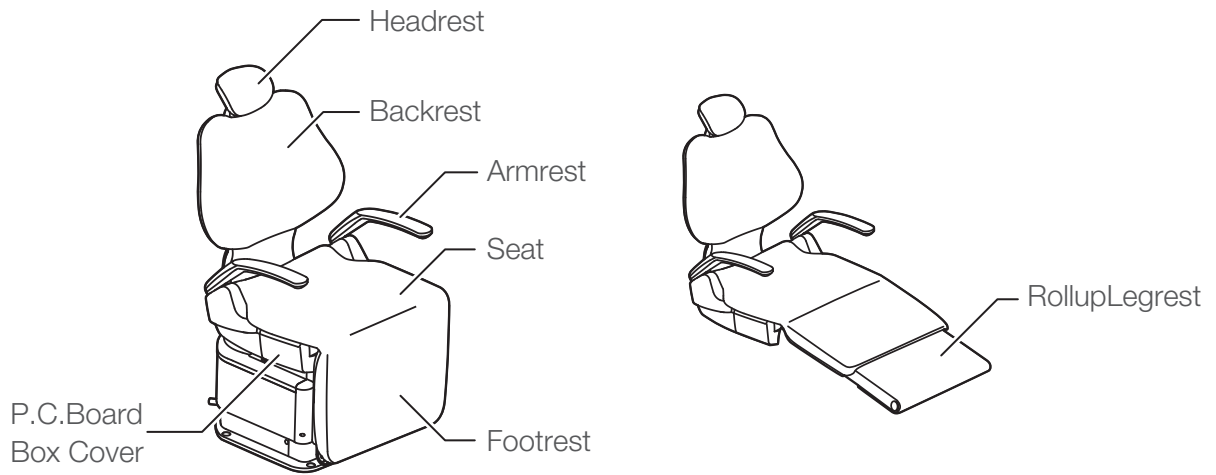

4-2-3-2 Headrest

Manual Headrest Type

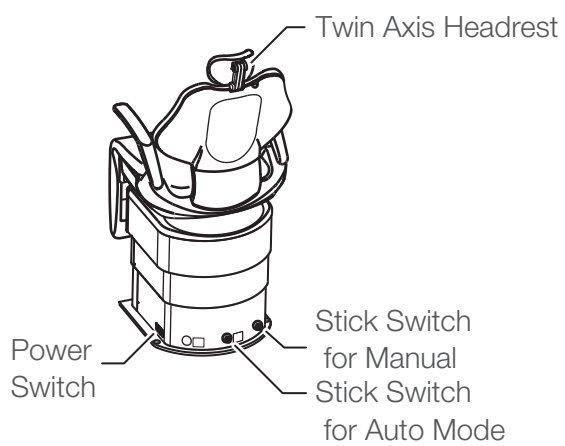

Power Headrest Type

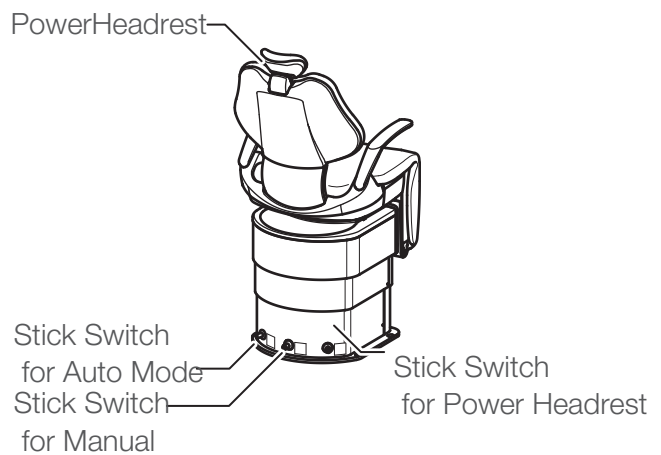

4 Specifications and Operation

4-2-4 Operation

4-2-4-1 Preparation Before Use

Turning on the power

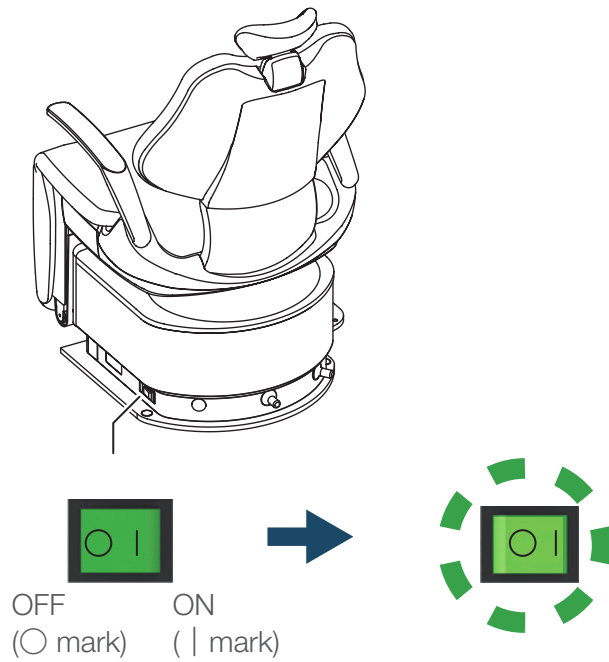

CAUTION

Operate the main switch for chair by hand.

4-2-4-2 After use

Turn off the power for chair



CAUTION

Operate the main switch for chair by hand.

4 Specifications and Operation

4-2-4-3 Raising/lowering the chair and raising/reclining the backrest (manual operation)

Manual Headrest Type

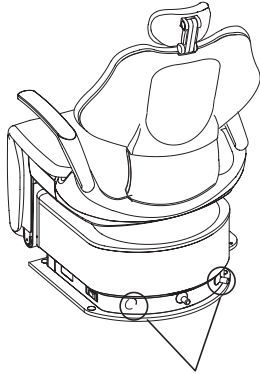

Stick Switch for Manual Operation

Power Headrest Type

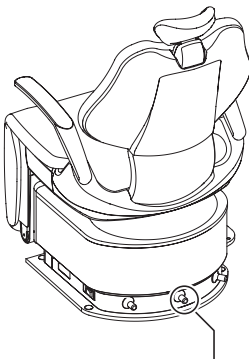

Stick Switch for Manual Operation

| Stick switch | | Operation |
|-------------------|------------------|-----------|
| Pushing direction | Label indication | |
| | | |
| | | |
| | | |
| | | |

*The chair is operated while the stick switch is pushed down or the switch is pressed.

WARNING

Before raising/lowering the chair, ensure that the chair does not contact any body parts, hands, feet, or objects.

Before reclining the backrest, confirm that the patient's arm or hand is not placed between the backrest and the seat.

Before raising the backrest, confirm that the patient's arm or hand is not placed between the backrest and the armrest.

[Reference] Precautions when a patient is seated

4 Specifications and Operation

4-2-4-4 Moving the chair to the preset position (automatic operation)

Manual Headrest Type

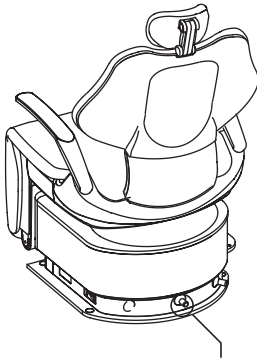

Stick Switch for Auto Operation

Power Headrest Type

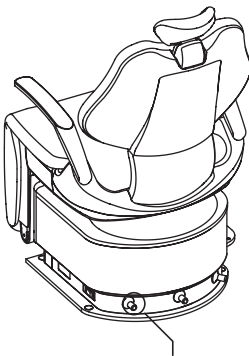

Stick Switch for Auto Operation

| Stick switch | | Operation |
|-------------------|------------------|--|
| Pushing direction | Label indication | |
| | | "Treatment position 1". |
| | | "Treatment position 2". |
| | | "Entry/exit position". |
| | | "Return headrest".(Power headrest) |
| | | "mouth rinsing position". |
| | | "Previous position". |

Do not depress the auto operation stick switch for over 5 seconds, because the memorized position in auto mode may be changed. [Reference] Changing Treatment Position, Mouth rinsing Position and Entry/Exit Position

WARNING

Before moving the chair, confirm that no human body part, limb, or object is obstructing the chair.

4-2-4-5 Operating the headrest (manual type)

Adjustment of the headrest

The headrest is capable of flexibly adjusting the inclination of the patient's head for treatment in the upper/lower jaw. It is also possible to manually extend/fold the headrest in accordance with the patient's height.

Angle adjustment of the headrest

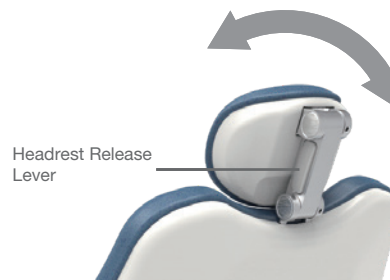

Up/down adjustment of the headrest



Do not apply excessive load or impact to the headrest while it is extended. Do not hit the headrest from above. Otherwise, failure may result.

WARNING

If the chair is to be moved with the backrest reclined while the headrest is extended, confirm that there is no object obstructing or coming into contact with the chair. This may cause damage or injury.

When operating the headrest, be careful not to get the operator's hand or finger caught around the control lever or between the headrest and the backrest.

When adjusting the angle or up/down, be sure to apply the operator's hand to the headrest and support the patient's head. Otherwise, an accident or injury may result.

4 Specifications and Operation

4-2-4-6 Operating the headrest (Power Headrest Type)

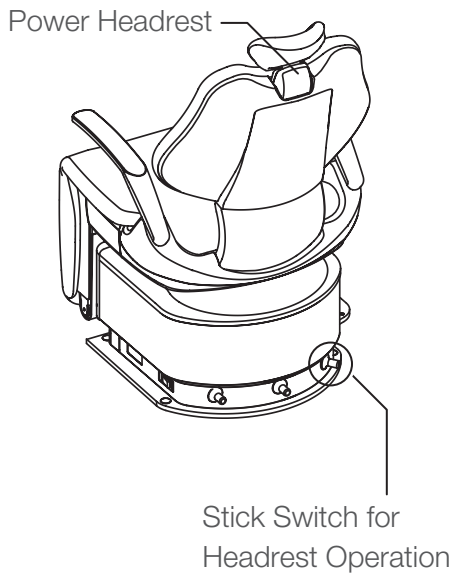

| Stick switch | | Operation |
|-------------------|------------------|-------------|
| Pushing direction | Label indication | |
| | | Extend |
| | | Lower |
| | | Raise |
| | | Recline |

*The chair is operated while the stick switch is pushed down.

Do not apply an excessive load or impact on the headrest. Otherwise, failure may result.

WARNING

When operating the headrest, check that the patient's head is in the correct position, and closely watch the patient during operation.

Be careful when operating the headrest that fingers and other body parts are not pinched in between the headrest and backrest.

4 Specifications and Operation

4-2-4-7 Relationship among the angles of the backrest, legrest and roll up legrest

Manual Headrest Type

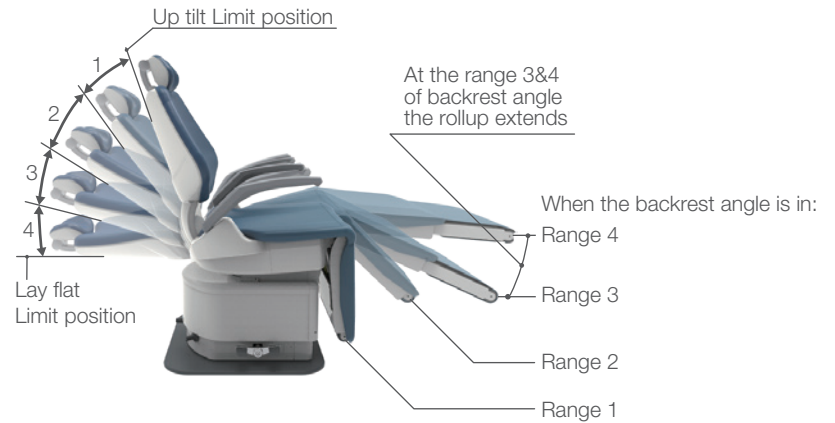

Power Headrest Type

Headrest up/down position

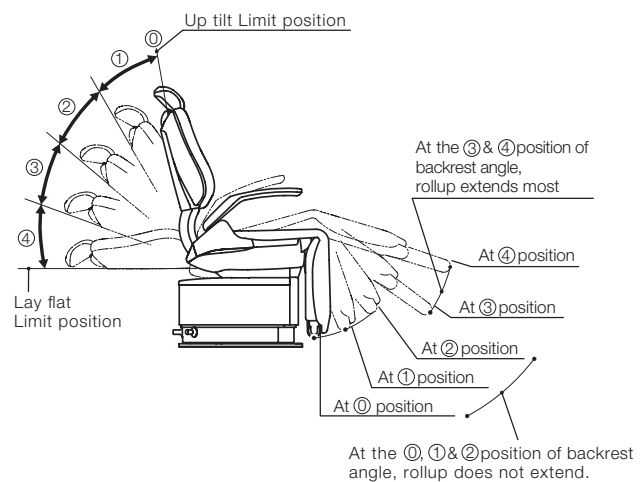
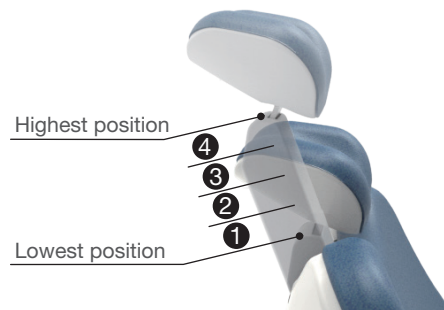

4 Specifications and Operation

4-2-4-8 Turning the armrest

If the armrest hinders entry/exit or diagnosis, it may be turned backward.

Both the left and right armrests can be turned.



CAUTION

When turning the armrest, confirm that there is no obstruction.

Operator must be careful not to get their hand or finger caught.
Do not move the chair while the armrest has been turned backward.
Return the armrest to the normal position before moving the chair.

4 Specifications and Operation

4-2-4-9 Cancellation function

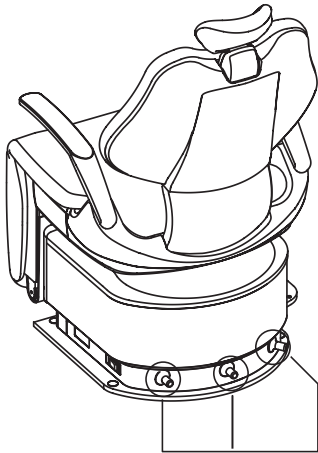

Stick Switch

To stop the chair movement started by a switch for automatic operation (preset switch, automatic return switch, last position switch, or stick switch for automatic operation), perform one of the following operations.

Operate one of the stick switches (indicated with ○).

4-2-4-10 Chair lock function

When the lock function is activated, the chair movement is stopped. The functions that become locked and the unlocking steps are as follows.

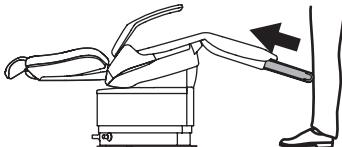
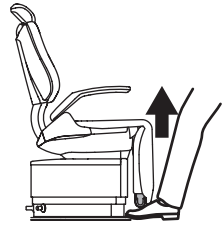
| Condition | How to unlock |
|---|--|
| <p>If a certain amount of force is applied in the direction of the arrow to the roll up legrest during operation, the pinching prevention function will operate, and the seat will rise for approx. 1 second and then stop.</p> | <p>Remove the cause of the stoppage, confirm the safety, then restart operation.</p> |
| <p>*While the legrest is rising by auto operation, the pinching prevention function will operate within the range of the legrest vertical to approx. 55°. Beyond this range, the pinching prevention function will not operate.</p> | <p style="text-align: center;">Locked functions</p> <p>Automatic operation of the chair Manual operation (lowering, reclining the backrest)</p> |
| <p>Legrest is rising by auto operation</p> | |
|  | |
| <p>Lowering by manual / auto operation</p> | |
|  | |

4 Specifications and Operation

4-2-4-11 Setting the treatment and entry/exit positions

Manual Headrest Type

Power Headrest Type

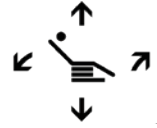
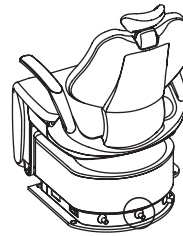

Set the treatment position by chair manual switch



Manual Headrest Type

Power Headrest Type

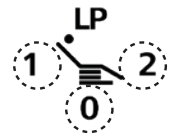
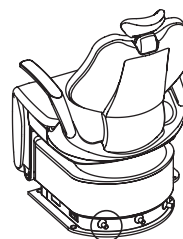

Keep pressing 5seconds.
1,2: Chair preset position
0:Auto return position

4-2-4-12 Setting the mouth rinsing position

Manual Headrest Type

Power Headrest Type

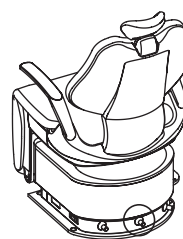

Set the treatment position by chair manual switch



Manual Headrest Type

Power Headrest Type

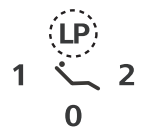

Keep pressing 5seconds.
LP: Last position

5-1 Methods for Care

Clean this chair after use to maintain it in a clean state.

WARNING

Turn off the power switch and unplug the power plug before cleaning. Failure to do so can result in electric shock or fire. Also, sudden movement of the chair while cleaning can result in injury.

Do not wash with water. This may cause failure or electric shock.

Poor cleaning may cause bacteria to grow, posing a health risk.

CAUTION

The metal and mechanical parts of the chair have sharp edges. Be careful when cleaning the chair that your hands, fingers or other body parts are not injured.

Leather Parts and Plastic Parts

Wipe gently off with a dry soft cloth.

If extremely dirty

Wipe off any stain by using a soft cloth that has been dabbed with a neutral detergent diluted with water to approximately 10%, wipe it with a damp cloth and thoroughly wipe it dry.

Parts touched by the patient

Use a soft cloth saturated with disinfectant to clean the cushion parts, such as the headrest, backrest, seat, legrest, and armrest, as well as the other parts possibly touched by the patient.

As an example of disinfectant solutions for cleaning, use FD366 manufactured by Dürr.

Control Panels and Metal Parts

Wipe clean using a dry soft cloth.

Do not clean these parts with a wet cloth because they are readily affected by moisture and water. Wipe off all moisture immediately if any water gets on these parts. Water left on these parts will result in rust or malfunction of electronic parts.

Do not use any of the following substances to clean the chair. Thinner, nail polish remover, volatile chemicals (such as gasoline or kerosene), acid or alkaline solutions, chlorinated cleaners, disinfectants that are highly corrosive to metal, povidone iodine (iodine solution), sodium hypochlorite, waxes containing abrasive compounds, sponges containing abrasive compounds and similar substances.

Do not use brushes, scouring brushes or similar items when cleaning the chair. Using them will damage the chair or result in the inability to clean off the dirt or grime.

Do not clean leather parts using a cleaner or bleach containing organic solvent or abrasive compounds. Such substances can cause the leather surface to deteriorate or dull the luster.

Clean a chair that has not been used for an extended period before using again. After cleaning, be sure to always check that the chair operates properly.

5 Maintenance and Cleaning by Dental Staff

5-2 Maintenance and Inspection

5-2-1 Notes on daily maintenance and inspection (by the user)

It is the responsibility of the user (medical institution) to ensure that the medical device is correctly maintained and inspected. To ensure safe use of this product, the product must be inspected at the specified intervals as described in the table below.

If the chair does not work normally, immediately stop using the chair, turn off the power, unplug the power plug, and contact your local authorized Belmont dealer.

| No. | Item | Frequency | Inspection method and diagnosis | Influence if inspection not conducted | Maintenance required in case of nonconformity |
|-----|--|---------------|---|---|--|
| 1 | Confirmation of the cancel function for auto operation | Before start | Operation should stop if any of the stick switches is pushed during auto operation. | Unexpected personal injury and troubles may arise due to motion of the chair during medical treatment and due to pinching between doctor section and chair. | Contact your local authorized Belmont dealer if any abnormality arises. |
| 2 | Power supply cable | Before start | Power supply cable should not be abnormally bent, pinched or damaged, and the plug should be firmly inserted to the power socket and not covered with dust. | Accident or defect of the equipment. | Clean and rearrange the cable. For replacement, contact your local authorized Belmont dealer. |
| 3 | Function of each switch | Before start | Each switch for chair operation should work correctly. | Defect of movement may cause an accident. | Contact your local authorized Belmont dealer if any abnormality arises. |
| 4 | Moving parts | Before start | Make sure that the chair does not make any abnormal noise during automatic and manual movement. | Accident or defect of the equipment. | Contact your local authorized Belmont dealer if any abnormality arises. |
| 5 | Oil leakage | Before start | Make sure that there is no hydraulic oil on the floor or chair base leaking from the cylinder. | Defect of the equipment. | Contact your local authorized Belmont dealer if any abnormality arises. |
| 6 | Maintenance Exterior | After closing | Check that no chemical solution or dirty water adheres to or remains on the exterior of the product. | Any liquid remaining will cause discoloration or change the properties of the exterior or cause metal parts to rust. | Clean it. |
| 7 | Main power switch | After closing | Make sure that the main power switch is off | Accident or defect of the equipment | In the case the main power cannot be turned off, contact your local authorized Belmont dealer. |



WARNING

Always refer to this Instructions for Use before conducting daily maintenance and inspection.

If you do not conduct daily maintenance or inspection, use of the product may result in injury or damage to nearby devices.

5-2-2 Notes for periodic inspection

The product contains parts that stop functioning or wear depending on the use frequency, and therefore it is important to carry out maintenance in a periodic inspection once a year (including replacement of consumables) and safety checks.

Service parts required for the periodic inspection (including consumables) are listed in the table below. However, depending on the specifications of your device, there may be alternative parts available that differ from those listed in the table below.

Maintenance and inspection can be outsourced to qualified persons such as authorized repairers of medical devices. If you have any question about periodic inspection, contact your local authorized Belmont dealer.

List of service parts required for the periodic inspection

| Parts Description | Standard Lifetime | Parts Description | Standard Lifetime |
|---------------------------------|-------------------|---|-------------------|
| Headrest moving parts | 2 years | Armrest moving parts | 5 years |
| Electric wiring of moving parts | 5 years | Hydraulic moving part (O-ring, Packing) | 5 years |
| Switches | 5 years | Solenoid Valve | 7 years |
| Backrest moving parts | 5 years | Moving part | 7 years |
| Legrest moving parts | 5 years | Control PCBs. | 5 years |

List of consumables required for periodic inspection

| Parts Description |
|-------------------|
| O-ring, Packing |



Always entrust periodic inspection to your local authorized Belmont dealer. If you do not carry out periodic inspection, use of the product may cause injury or damage to nearby devices.

5-3 Storage method

In case of not using the product for a long period, store it in the following conditions.

1. Set the chair to the lowest position and the backrest to the most reclined position and lower the legrest.
2. Make sure to disconnect the power supply plug from the socket.

5 Maintenance and Cleaning by Dental Staff

5-4 Environmental Conditions for Transportation or Packaging

- (1) Environmental conditions for the transportation or packaging for Estorage of the product shall be as specified below.

Temperature -20 ~ 70°C
Humidity 10 ~ 95%
Air pressure 700 ~ 1060 hPa

- (2) Pay attention to the following items for the storage area.

Store the equipment in places with water not sprayed on it.

Store the equipment in places where it has no adverse influences of atmospheric pressure, temperature, humidity, ventilation, sunlight, dust, and air containing salt or sulfur.

Pay careful attention to keep the equipment in a steady state, avoiding inclination, vibration, and shock (including those during transport).

Do not store the equipment in places where chemicals are stored or gases are generated.

6 Maintenance by Service Engineers

6-1 After-sales Service

When you request for repair

Refer to 'Troubleshooting' before you check the device. If the problem persists, turn off the main switch, and contact your local authorized Belmont dealer to request a repair.

6-2 Service Life

The service life of this product is 10 years on condition that maintenance and inspection are properly conducted [according to our self-certification (our data)].

However, the standard service lives of service parts that require periodic inspection vary according to the part.

6-3 Period of Parts Retention

We hold service parts such as consumables for products for 10 years from the time of purchase.

* Service parts are parts required for repair to return the product to the original state and functions or to maintain its functions.

7 Troubleshooting

7-1 Troubleshooting

If you encounter any of the problems listed below, take the countermeasures described below before requesting a repair. If the problem persists even after troubleshooting, stop using the product immediately, turn off the power switch, and contact your local authorized Belmont dealer.

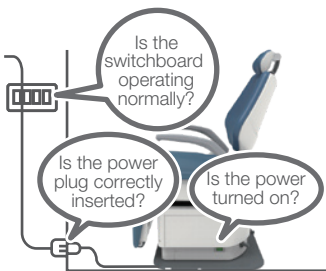
| Problem | Check Points | Recovery Procedures |
|--|---|---|
| <p>The product does not work at all.</p>  | Is the power plug fully inserted to the base of the plug? | Fully insert the power plug into the socket until reaching the base of the plug. |
| | Is power switch on? | Turn on the power switch. |
| | Has a fuse or a breaker on the clinic's switch board blown? | Replace the fuse or turn on the breaker. |
| | Has the chair been operated for an extended period continuously? | <p>The problem is due to the operation of the overheating prevention device. ⇒Leave the chair for approximately 10 min. to allow it to return to the normal condition.</p> <p>Overheating Prevention Device This is a protective circuit that prevents abnormal overheating of internal mechanisms due to continuous operation and similar causes. The chair might stop operating temporarily.</p> |
| The chair unexpectedly stops. | Is there an object interfering with the roll up legrest and applying a force to it? | The problem is due to the operation of the pinching prevention function. Remove the cause of the stoppage and operate the chair. |

| These are not malfunctions | |
|-------------------------------|--|
| Sound at startup | Such sound is due to the internal hydraulic fluid being cold. It is not a functional fault and should stop shortly thereafter. |
| Slow movement of the chair | Such movement is due to the internal operating fluid being cold. Raise the room temperature or continue operating for a short period. It will recover to the normal condition. |
| Sound when rotating the chair | This is the sound of the steel balls rolling when the chair is rotated. The level of this sound varies depending on the environment where the chair is installed. |

8 Accessories and Consumables

8-1 Accessories

Check that all the following accessories are present.
If anything is missing or damaged, contact your local authorized Belmont dealer.

- IFU information
- Installation Instructions

8-2 Consumables

Consumables are parts that will normally wear or deteriorate, change their appearance, or become damaged after use.

Please note that repair or replacement of consumables are not covered by the warranty and will be charged for.

(* Degree of wear, deterioration or damage and timing for replacement depends on the use environment and conditions at the customer's premises.)

Consumables (Parts listed below are out of the guarantee coverage and charged parts.)

O-ring, Packing

Exterior parts, including leather parts, metal parts, and resin parts, are not subject to warranty for such as scratches, dirt, deterioration and discoloration.



TAKARA COMPANY EUROPE GmbH

Berner Strasse 18, 60437
Frankfurt am Main, Germany
TEL : +49-69-506878-0
FAX : +49-69-506878-20



 **Belmont**

TAKARA BELMONT CORPORATION



2-1-1, Higashishinsaibashi, Chuo-ku, Osaka, 542-0083, Japan
TEL : +81-6-6213-5945
FAX : +81-6-6212-3680